

Applicable to special uses

- Hydraulic cylinders with bores of 40 to 250 mm designed to be installed and used on heavy machinery including steel mills
- Heavy-duty type resistant to surge pressure, vibration and impact
- High-performance hydraulic cylinders designed through careful examination of machining accuracy, surface treatment and sealing materials.
- Design based on advanced techniques allows the cylinders to be used for special purposes.
- Conforming to JOHS-110 of the Japan Fluid Power Association

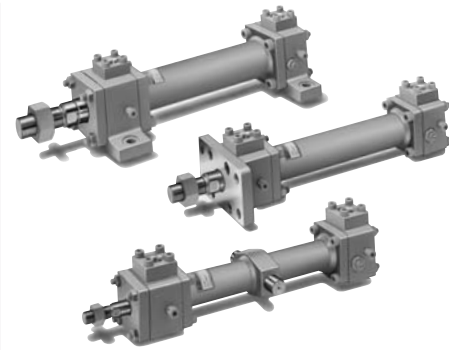

Standard Specifications

Type	70M-3	140M-3
Nominal pressure	7 MPa	14 MPa
Maximum allowable pressure	14 MPa	23 MPa
Proof pressure	17 MPa	28 MPa
Minimum operating pressure	$\phi 40$ to $\phi 140$: 0.3 $\phi 160$ to $\phi 250$: 0.5	
Working speed range	$\phi 40$ to $\phi 160$: 10 to 500mm/s $\phi 160$ to $\phi 250$: 20 to 500mm/s	
Working temperature range (ambient temp. and oil temp.)	-10°C to +80°C (no freezing)	
Structure of cushioning	Metal fitting system	
Paint color	Munsell 7.5 BG 5.5/2.5	
Applicable fluid	Petroleum-based fluid (When using another fluid, refer to the table of fluid adaptability.)	
Tolerance for thread	JIS 6g/6H	
Tolerance of stroke	0 to 100mm $^{+0.8}_0$ 101 to 250mm $^{+1.0}_0$ 251 to 630mm $^{+1.25}_0$ 631 to 1000mm $^{+1.4}_0$ 1001 to 1600mm $^{+1.6}_0$ 1601 to 2000mm $^{+1.8}_0$	
Mounting style	SD, LA, FA, FB, CA, TC	
Accessory	Boots	Standard : Nylon tarpaulin Semi-standard : Chloroprene, Conex
	Rod end attachment	Rod eye (T-end), rod clevis (Y-end)
	Others	Lock nut

Standard Stroke Range

Mounting styles other than TC Unit: mm

Cylinder bore	$\phi 40$ to $\phi 63$	$\phi 80$ to $\phi 160$	$\phi 180$ to $\phi 250$
Stroke range	0 to 2000	51 to 2000	101 to 2000

TC style Unit: mm

Cylinder bore	$\phi 40$ to $\phi 80$	$\phi 100$ · $\phi 125$	$\phi 140$ to $\phi 200$	$\phi 224$ · $\phi 250$
Stroke range	101 to 2000	151 to 2000	201 to 2000	251 to 2000

- The above strokes indicate the maximum available strokes for the standard type.
- For the rod buckling, check with the buckling chart in the selection materials. Contact us for longer strokes.

Terminologies

Nominal pressure
Pressure given to a cylinder for convenience of naming. It is not always the same as the working pressure (rated pressure) that guarantees performance under the specified conditions.

Maximum allowable pressure
Maximum allowable pressure generated in a cylinder (surge pressure, etc.).

Proof pressure
Test pressure against which a cylinder can withstand without unreliable performance at the return to nominal pressure.

Minimum operating pressure
Minimum pressure at which cylinder installed horizontally operates under no load.

- Notes)
- The hydraulic pressure generated in a cylinder due to the inertia of load must be lower than the maximum allowable pressure.
 - Conex is the registered trademark of Teijin Limited.
 - For the internal structure, refer to the sectional drawings at the end of this catalog.

Cushion Stroke Length Unit: mm

Cylinder bore	Cushion ring length	Cylinder bore	Cushion ring length
$\phi 40$ to $\phi 63$	20	$\phi 180$ to $\phi 224$	30
$\phi 80$ to $\phi 160$	25	$\phi 250$	35

- The cushion stroke lengths in case of cylinders used up to the stroke end.
- In the case that a cylinder is not used up to the stroke end, and it is stopped 5 mm or more before the stroke end, the cushioning effect will be weakened. In this case, consult us. The following cylinders do not have cushions.
- Rod diameter type A : Rod side of cylinders with bores of 40, 50 and 63 mm
- Rod diameter type B : Rod side of cylinders with a bore of 40 mm

Product Lineup

Unit: mm

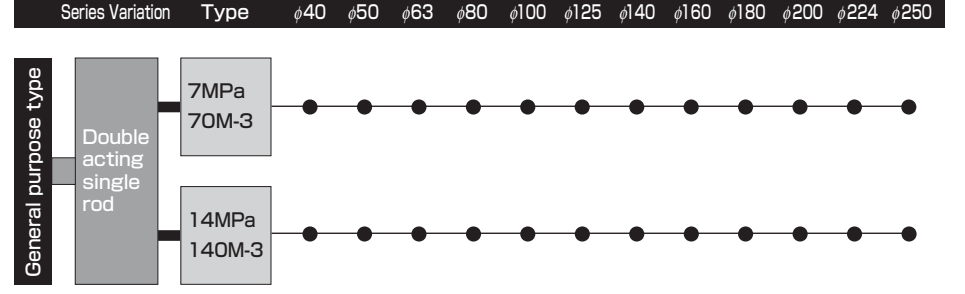

Adaptability of Fluid to Seal Material

Seal material	Applicable fluid				
	Petroleum-based fluid	Water-glycol fluid	Phosphate ester fluid	Water in oil fluid	Oil in water fluid
2 Urethane rubber (standard)	◎	×	×	△	△
1 Nitrile rubber	○	○	×	○	○
3 Fluorocarbon	○	×	○	○	○

- Notes) 1. ◎ : Applicable × : Inapplicable Consult us before using the △-marked items.
2. The ◎-marked items are recommended seal materials in case of giving the first priority to abrasion-proof.

Piston Pressurized Area Table

Bore (mm)	$\phi 40$		$\phi 50$		$\phi 63$		$\phi 80$		$\phi 100$		$\phi 125$		$\phi 140$		$\phi 160$		$\phi 180$		$\phi 200$		$\phi 224$		$\phi 250$	
	A	B	A	B	A	B	A	B	A	B	A	B	A	B	A	B	A	B	A	B	A	B	A	B
Rod dia. (mm)	$\phi 28$	$\phi 22.4$	$\phi 35.5$	$\phi 28$	$\phi 45$	$\phi 35.5$	$\phi 56$	$\phi 45$	$\phi 71$	$\phi 56$	$\phi 90$	$\phi 71$	$\phi 100$	$\phi 80$	$\phi 112$	$\phi 90$	$\phi 125$	$\phi 100$	$\phi 140$	$\phi 112$	$\phi 160$	$\phi 125$	$\phi 180$	$\phi 140$
Pressurized area mm ²	640	862	973	1347	1526	2127	2563	3436	3894	5390	5910	8312	7539	10367	10254	13744	13175	17592	16022	21563	19301	27136	23640	33693

How to order

General Purpose Type

The item enclosed by broken line needs not to be entered, if unnecessary. Semi-standard specification

● Standard type: 140M-3

70M-3 : For 7 MPa
140M-3 : For 14 MPa

② Urethane rubber (standard)
① Nitrile rubber (semi-standard)
③ Fluorocarbon (semi-standard)

Mounting style: 2

Cylinder bore (mm) $\phi 40$ to $\phi 250$: LA, 80, A, B

Cylinder stroke (mm): 100

Port position (A, B, C, D): A, B

Cushion valve position (A, B, C, D, or O): 1, 2, E

Port type (X, Y, Z): X, T

Relief attachment: J

Boots: J, JN, JK

J Nylon tarpaulin
JN Chloroprene
JK Conex
T T-end (rod eye)
Y Y-end (rod clevis)

A Rod A
B Rod B
B With cushion on both ends
R With cushion on rod side
H With cushion on cap side
N No cushion

Standard specifications

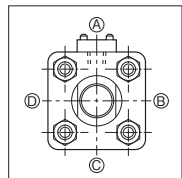

- With cushions on both ends
- Port position (A)
- Seal material : Urethane rubber

The rod seals of cylinders with bores of 160 mm or more are made of fabric-filled rubber and nitrile rubber.

Port and cushion valve positions

The standard port position is (A), and the standard cushion valve position is (B).

When modifying the positions, enter the symbol shown in the dimensional drawings. In case that the cushion is not equipped, the cushion valve position is "O".

(All symbols of the port positions and cushion valve positions are shown clockwise as viewed from the rod side.)

For cylinders with mounting style FA or FB ($\phi 40$ to $\phi 80$), ports cannot be made on (B) or (D).

Rod end thread type

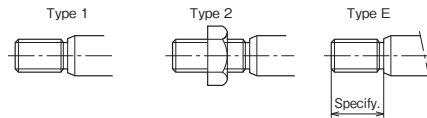

The end thread of type 2 is longer than that of type 1 and has a lock nut. If the customer does not specify the type, the cylinder will be provided with type 1 rod end thread.

Port type

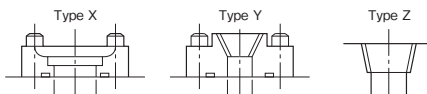

If the customer does not specify the type, the cylinder will be provided with type X port.

Mounting Style

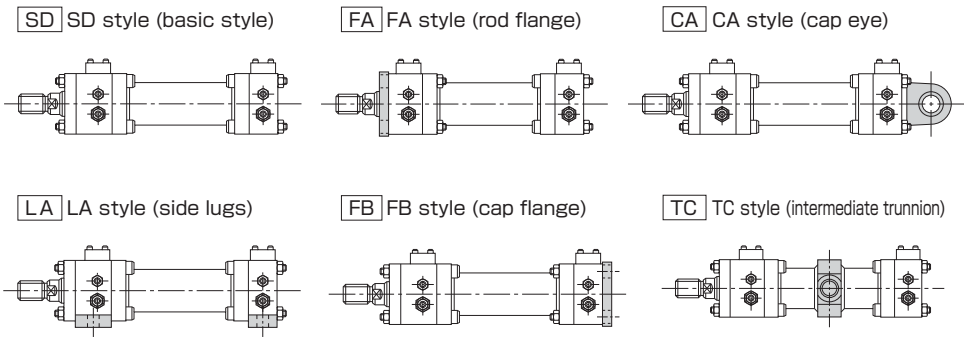

Adaptability of Fluid to Seal Material

Seal material	Applicable fluid				
	Petroleum-based fluid	Water-glycol fluid	Phosphate ester fluid	Water in oil fluid	Oil in water fluid
② Urethane rubber (standard)	◎	×	×	△	△
① Nitrile rubber	○	○	×	○	○
③ Fluorocarbon	○	×	○	○	○

Notes) 1. ◎○ : Applicable × : Inapplicable Consult us before using the △-marked items.
2. The ◎-marked items are recommended seal materials in case of giving the first priority to abrasion-proof.

Cushion Manufacturing Range

Bore	Rod A		Rod B	
	Extension side	Retraction side	Extension side	Retraction side
$\phi 40$	×	○	×	○
$\phi 50$	×	○		○
$\phi 63$	×	○		○
$\phi 80$		○		○
$\phi 100$		○		○
$\phi 125$		○		○
$\phi 140$		○		○
$\phi 160$		○		○
$\phi 180$		○		○
$\phi 200$		○		○
$\phi 224$		○		○
$\phi 250$		○		○

The following cylinders do not have cushions.
Rod A : Rod side of cylinders with bores of 40, 50 and 63 mm
Rod B : Rod side of cylinders with a bore of 40 mm

SD

70/140M-3 **2** SD **Bore B B** Stroke - **A B 1 X**

φ40 to φ140

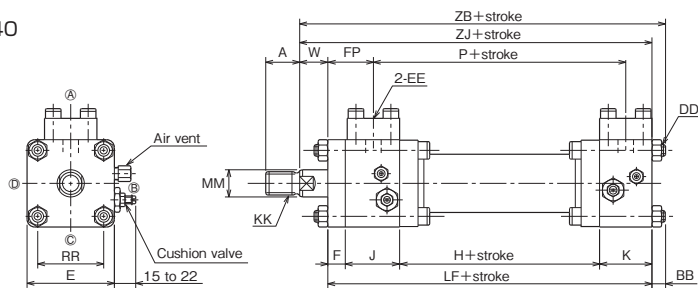

φ160 to φ250

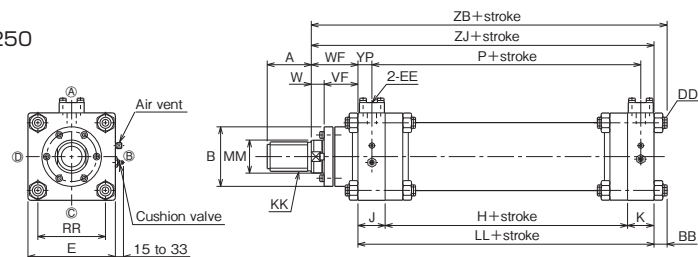

- The following cylinders do not have cushions.
Rod diameter type A : Rod side of cylinders with bores of 40, 50 and 63 mm
Rod diameter type B : Rod side of cylinders with a bore of 40 mm
- For the dimensions of the port flange, refer to "Accessories".
- The air vent and cushion valve positions vary depending on the cylinder bore.

Shape of rod end thread

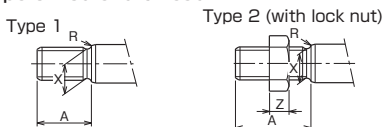

For the dimensions of the lock nut, refer to "Accessories".

Shape of rod end

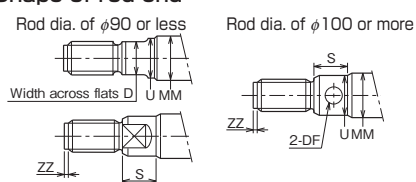

φ40 to φ140

- φ40 · φ50 1/3.5 (1/2.5) stroke+X
- φ63 to φ100 1/4 (1/3) stroke+X
- φ125 · φ140 1/5 (1/3.5) stroke+X

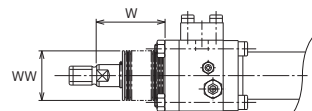

φ160 to φ250

- φ160 to φ200 1/5 (1/3.5) stroke+X
- φ224 · φ250 1/6 (1/4.5) stroke+X

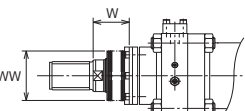

	Standard		Semi-standard	
	Material	Nylon tarpaulin	Chloroprene	Conex
Heat proof	80°C	130°C	200°C	

- Note that the parenthesized values apply in the case of Conex.
- The boots have been mounted at our factory prior to delivery.
- Conex is the registered trademark of Teijin Limited.

Symbol	WW		X
	Rod A	Rod B	
φ40	φ63	φ50	42
φ50	φ71	φ63	57
φ63	φ80	φ71	60
φ80	φ100	φ80	53
φ100	φ125	φ100	64
φ125	φ140	φ125	64
φ140	φ160	φ125	69
φ160	φ180	φ140	60
φ180	φ180	φ160	80
φ200	φ200	φ180	78
φ224	φ220	φ180	82
φ250	φ240	φ200	78

If the calculated value has a fractional part, round it up.

Dimensional Table

Symbol	Rod A												
	A		B	D	DF	KK	MM	R	S	U	X	Z	ZZ
	Type 1	Type 2											
φ40	35	55	—	24	—	M24×1.5	φ28	3	—	—	21.5	19	—
φ50	45	65	—	30	—	M30×1.5	φ35.5	3	—	—	27.5	24	—
φ63	60	85	—	41	—	M39×1.5	φ45	3	25	φ44	36.5	31	—
φ80	75	105	—	50	—	M48×1.5	φ56	3	28	φ55	45.5	38	—
φ100	95	140	—	65	—	M64×2	φ71	5	34	φ70	61	51	5
φ125	120	175	—	85	—	M80×2	φ90	5	39	φ89	77	64	5
φ140	140	210	—	—	φ12	M95×2	φ100	5	35	φ99	92	76	5
φ160	150	220	φ191	—	φ15	M100×2	φ112	5	30	φ111	97	80	5
φ180	180	265	φ208	—	φ15	M120×2	φ125	5	35	φ124	117	96	5
φ200	195	285	φ229	—	φ15	M130×2	φ140	5	33	φ139	127	104	5
φ224	225	330	φ253	—	φ15	M150×2	φ160	5	35	φ159	147	120	5
φ250	255	375	φ280	—	φ15	M170×3	φ180	5	35	φ179	165.5	136	8

Symbol	Rod B												
	A		B	D	DF	KK	MM	R	S	U	X	Z	ZZ
	Type 1	Type 2											
φ40	30	45	—	19	—	M20×1.5	φ22.4	3	—	—	17.5	16	—
φ50	35	55	—	24	—	M24×1.5	φ28	3	—	—	21.5	19	—
φ63	45	65	—	30	—	M30×1.5	φ35.5	3	25	φ34.5	27.5	24	—
φ80	60	85	—	41	—	M39×1.5	φ45	3	28	φ44	36.5	31	—
φ100	75	105	—	50	—	M48×1.5	φ56	3	34	φ55	45.5	38	—
φ125	95	140	—	65	—	M64×2	φ71	5	39	φ70	61	51	5
φ140	110	160	—	75	—	M72×2	φ80	5	40	φ79	69	58	5
φ160	120	175	φ162	85	—	M80×2	φ90	5	30	φ89	77	64	5
φ180	140	210	φ172	—	φ12	M95×2	φ100	5	35	φ99	92	76	5
φ200	150	220	φ191	—	φ15	M100×2	φ112	5	33	φ111	97	80	5
φ224	180	265	φ208	—	φ15	M120×2	φ125	5	35	φ124	117	96	5
φ250	195	285	φ229	—	φ15	M130×2	φ140	5	35	φ139	127	104	5

Symbol	BB	DD	E	EE	F	FP	H	J	K	LF	LL	P	RR	VF	W	WF	YP	ZB	ZJ
φ40	11	M10×1.5	□80	SSA15	18	47	64	56	54	192	—	118	□60	—	29	—	—	232	221
φ50	13	M12×1.75	□90	SSA15	18	47	68	56	54	196	—	122	□68	—	29	—	—	238	225
φ63	14	M14×2	□110	SSA15	20	61	87	68	54	229	—	141	□80	—	40	—	—	283	269
φ80	16	M16×2	□127	SSA20	26	70	97	73	58	254	—	155	□98	—	33	—	—	303	287
φ100	19	M20×2.5	□154	SSA20	31	87	96	85	58	270	—	154	□120	—	39	—	—	328	309
φ125	22	M24×2	□188	SSA25	36	105	106	103	68	313	—	174	□144	—	44	—	—	379	357
φ140	26	M27×2	□212	SSA25	36	105	116	103	68	323	—	184	□162	—	49	—	—	398	372
φ160	28	M30×2	□238	SSA25	—	—	132	74	72	—	278	204	□184	92	35	127	38	433	405
φ180	30	M33×2	□272	SSA32	—	—	142	84	82	—	308	224	□214	92	40	132	43	470	440
φ200	33	M36×2	□298	SSA40	—	—	152	102	102	—	356	254	□232	102	38	140	51	529	496
φ224	35	M39×2	□328	SSA40	—	—	162	102	102	—	366	264	□256	112	42	154	51	555	520
φ250	38	M42×2	□362	SSA50	—	—	172	111	102	—	385	274	□286	127	48	175	60	598	560

LA

70/140M-3 [2] LA Bore B B Stroke - A B 1 X

φ40 to φ140

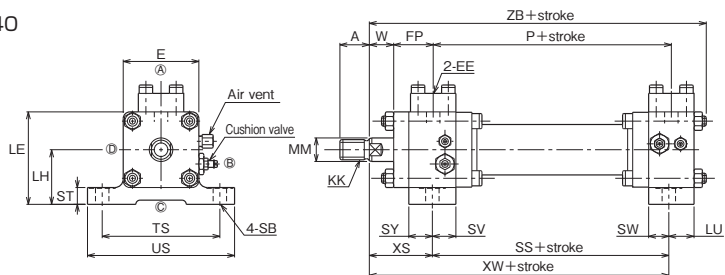

φ160 to φ250

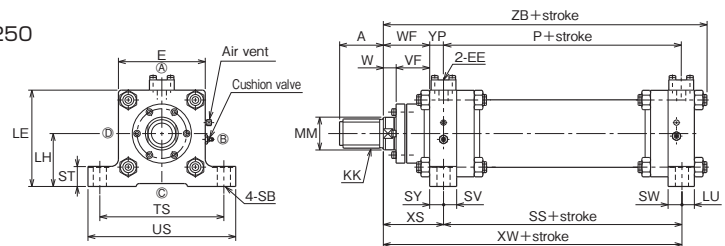

● The following cylinders do not have cushions.

Rod diameter type A : Rod side of cylinders with bores of 40, 50 and 63 mm
Rod diameter type B : Rod side of cylinders with a bore of 40 mm

● For the dimensions of the port flange, refer to "Accessories".

● The air vent and cushion valve positions vary depending on the cylinder bore.

Shape of rod end thread

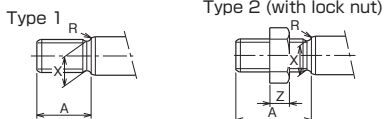

For the dimensions of the lock nut, refer to "Accessories".

Shape of rod end

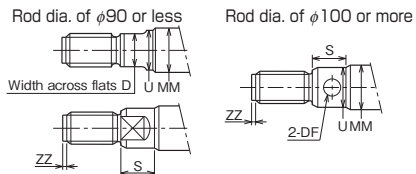

φ40 to φ140

φ40 · φ50 1/3.5 (1/2.5) stroke+X
φ63 to φ100 1/4 (1/3) stroke+X
φ125 · φ140 1/5 (1/3.5) stroke+X

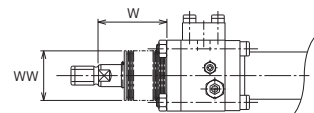

φ160 to φ250

φ160 to φ200 1/5 (1/3.5) stroke+X
φ224 · φ250 1/6 (1/4.5) stroke+X

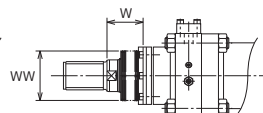

Symbol	WW		X
	Rod A	Rod B	
φ40	φ63	φ50	42
φ50	φ71	φ63	57
φ63	φ80	φ71	60
φ80	φ100	φ80	53
φ100	φ125	φ100	64
φ125	φ140	φ125	64
φ140	φ160	φ125	69
φ160	φ180	φ140	60
φ180	φ180	φ160	80
φ200	φ200	φ180	78
φ224	φ220	φ180	82
φ250	φ240	φ200	78

If the calculated value has a fractional part, round it up.

	Standard		Semi-standard	
	Material	Nylon tarpaulin	Chloroprene	Conex
Heat proof	80°C	130°C	200°C	

- Note that the parenthesized values apply in the case of Conex.
- The boots have been mounted at our factory prior to delivery.
- Conex is the registered trademark of Teijin Limited.

Dimensional Table

Symbol	Rod A											
	A		D	DF	KK	MM	R	S	U	X	Z	ZZ
	Type 1	Type 2										
φ40	35	55	24	—	M24×1.5	φ28	3	—	—	21.5	19	—
φ50	45	65	30	—	M30×1.5	φ35.5	3	—	—	27.5	24	—
φ63	60	85	41	—	M39×1.5	φ45	3	25	φ44	36.5	31	—
φ80	75	105	50	—	M48×1.5	φ56	3	28	φ55	45.5	38	—
φ100	95	140	65	—	M64×2	φ71	5	34	φ70	61	51	5
φ125	120	175	85	—	M80×2	φ90	5	39	φ89	77	64	5
φ140	140	210	—	φ12	M95×2	φ100	5	35	φ99	92	76	5
φ160	150	220	—	φ15	M100×2	φ112	5	30	φ111	97	80	5
φ180	180	265	—	φ15	M120×2	φ125	5	35	φ124	117	96	5
φ200	195	285	—	φ15	M130×2	φ140	5	33	φ139	127	104	5
φ224	225	330	—	φ15	M150×2	φ160	5	35	φ159	147	120	5
φ250	255	375	—	φ15	M170×3	φ180	5	35	φ179	165.5	136	8

Symbol	Rod B											
	A		D	DF	KK	MM	R	S	U	X	Z	ZZ
	Type 1	Type 2										
φ40	30	45	19	—	M20×1.5	φ22.4	3	—	—	17.5	16	—
φ50	35	55	24	—	M24×1.5	φ28	3	—	—	21.5	19	—
φ63	45	65	30	—	M30×1.5	φ35.5	3	25	φ34.5	27.5	24	—
φ80	60	85	41	—	M39×1.5	φ45	3	28	φ44	36.5	31	—
φ100	75	105	50	—	M48×1.5	φ56	3	34	φ55	45.5	38	—
φ125	95	140	65	—	M64×2	φ71	5	39	φ70	61	51	5
φ140	110	160	75	—	M72×2	φ80	5	40	φ79	69	58	5
φ160	120	175	85	—	M80×2	φ90	5	30	φ89	77	64	5
φ180	140	210	—	φ12	M95×2	φ100	5	35	φ99	92	76	5
φ200	150	220	—	φ15	M100×2	φ112	5	33	φ111	97	80	5
φ224	180	265	—	φ15	M120×2	φ125	5	35	φ124	117	96	5
φ250	195	285	—	φ15	M130×2	φ140	5	35	φ139	127	104	5

Symbol	E	EE	FP	LE	LH	LU	P	SB	SS	ST	SV	SW	SY	TS	US	VF	W	WF	XS	XW	YP	ZB
φ40	80	SSA15	47	100	60±0.15	26	118	φ14	120	20	28	28	28	125±0.5	155	—	29	—	75	195	—	232
φ50	90	SSA15	47	110	65±0.15	30	122	φ16	120	20	28	24	28	140±0.5	175	—	29	—	75	195	—	238
φ63	110	SSA15	61	125	70±0.15	24	141	φ18	150	25	33	30	35	155±0.5	190	—	40	—	95	245	—	283
φ80	127	SSA20	70	143.5	80±0.25	27	155	φ20	165	30	37	31	36	180±0.5	220	—	33	—	95	260	—	303
φ100	154	SSA20	87	172	95±0.25	29	154	φ24	165	35	40	29	45	220±0.5	265	—	39	—	115	280	—	328
φ125	188	SSA25	105	209	115±0.25	32	174	φ30	195	40	53	36	50	275±0.8	330	—	44	—	130	325	—	379
φ140	212	SSA25	105	231	125±0.25	37	184	φ33	200	45	53	31	50	305±0.8	365	—	49	—	135	335	—	398
φ160	238	SSA25	—	264	145±0.25	34	204	φ36	206	55	36	38	38	340±0.8	405	92	35	127	165	371	38	433
φ180	272	SSA32	—	296	160±0.25	40	224	φ39	225	60	41	42	43	375±0.8	445	92	40	132	175	400	43	470
φ200	298	SSA40	—	324	175±0.25	51	254	φ42	250	65	47	51	55	410±0.8	485	102	38	140	195	445	51	529
φ224	328	SSA40	—	359	195±0.25	50	264	φ48	265	70	51	52	51	460±0.8	545	112	42	154	205	470	51	555
φ250	362	SSA50	—	396	215±0.25	48	274	φ52	282	75	56	54	55	500±0.8	590	127	48	175	230	512	60	598

FA

70/140M-3 [2] FA Bore [B] [B] Stroke - [A] [B] [1] [X]

φ40 to φ140

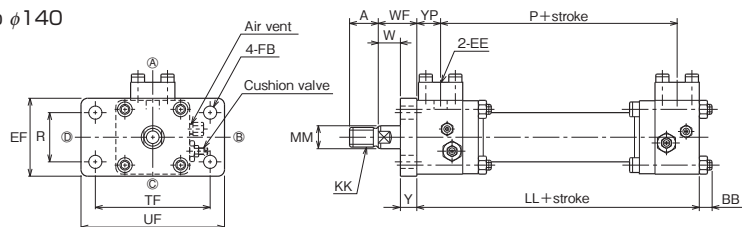

φ160 to φ250

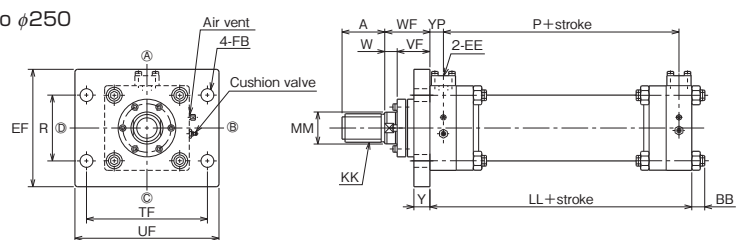

- The following cylinders do not have cushions.
Rod diameter type A : Rod side of cylinders with bores of 40, 50 and 63 mm
Rod diameter type B : Rod side of cylinders with a bore of 40 mm
- For the dimensions of the port flange, refer to "Accessories".
- The air vent and cushion valve positions vary depending on the cylinder bore.
- In the case of mounting style FA (φ40 to φ80), the port cannot be positioned on ⊕ or ⊙.

Shape of rod end thread

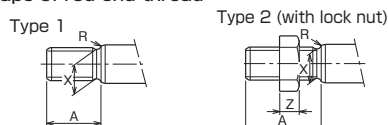

For the dimensions of the lock nut, refer to "Accessories".

Shape of rod end

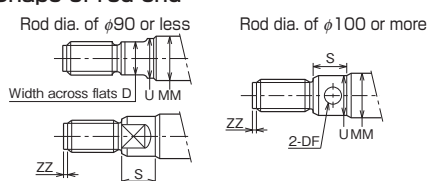

φ40 to φ140

- φ40 · φ50 1/3.5 (1/2.5) stroke+X
- φ63 to φ100 1/4 (1/3) stroke+X
- φ125 · φ140 1/5 (1/3.5) stroke+X

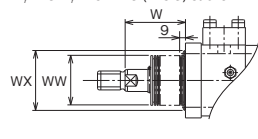

φ160 to φ250

- φ160 to φ200 1/5 (1/3.5) stroke+X
- φ224 · φ250 1/6 (1/4.5) stroke+X

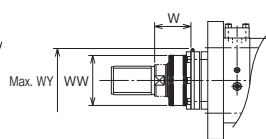

	Standard		Semi-standard	
	Nylon tarpaulin	Chloroprene	Conex	
Heat proof	80°C	130°C	200°C	

- Note that the parenthesized values apply in the case of Conex.
- The boots have been mounted at our factory prior to delivery.
- Conex is the registered trademark of Teijin Limited.

Symbol	WW		WX		WY		X
	Rod A	Rod B	Rod A	Rod B	Rod A	Rod B	
φ40	φ63	φ50	φ80	φ78	-	-	45
φ50	φ71	φ63	φ90	φ90	-	-	55
φ63	φ80	φ71	φ108	φ100	-	-	55
φ80	φ100	φ80	φ128	φ108	-	-	65
φ100	φ125	φ100	φ154	φ128	-	-	65
φ125	φ140	φ125	φ168	φ154	-	-	65
φ140	φ160	φ125	φ188	φ154	-	-	65
φ160	φ180	φ140	-	-	φ220	φ192	60
φ180	φ180	φ160	-	-	φ238	φ202	80
φ200	φ200	φ180	-	-	φ259	φ220	78
φ224	φ220	φ180	-	-	φ283	φ238	82
φ250	φ240	φ200	-	-	φ310	φ259	78

If the calculated value has a fractional part, round it up.

Dimensional Table

Symbol	Rod A												
	A		B	D	DF	KK	MM	R	S	U	X	Z	ZZ
	Type 1	Type 2											
φ40	35	55	-	24	-	M24×1.5	φ28	3	-	-	21.5	19	-
φ50	45	65	-	30	-	M30×1.5	φ35.5	3	-	-	27.5	24	-
φ63	60	85	-	41	-	M39×1.5	φ45	3	25	φ44	36.5	31	-
φ80	75	105	-	50	-	M48×1.5	φ56	3	28	φ55	45.5	38	-
φ100	95	140	-	65	-	M64×2	φ71	5	34	φ70	61	51	5
φ125	120	175	-	85	-	M80×2	φ90	5	39	φ89	77	64	5
φ140	140	210	-	-	φ12	M95×2	φ100	5	35	φ99	92	76	5
φ160	150	220	φ191	-	φ15	M100×2	φ112	5	30	φ111	97	80	5
φ180	180	265	φ208	-	φ15	M120×2	φ125	5	35	φ124	117	96	5
φ200	195	285	φ229	-	φ15	M130×2	φ140	5	33	φ139	127	104	5
φ224	225	330	φ253	-	φ15	M150×2	φ160	5	35	φ159	147	120	5
φ250	255	375	φ280	-	φ15	M170×3	φ180	5	35	φ179	165.5	136	8

Symbol	Rod B												
	A		B	D	DF	KK	MM	R	S	U	X	Z	ZZ
	Type 1	Type 2											
φ40	30	45	-	19	-	M20×1.5	φ22.4	3	-	-	17.5	16	-
φ50	35	55	-	24	-	M24×1.5	φ28	3	-	-	21.5	19	-
φ63	45	65	-	30	-	M30×1.5	φ35.5	3	25	φ34.5	27.5	24	-
φ80	60	85	-	41	-	M39×1.5	φ45	3	28	φ44	36.5	31	-
φ100	75	105	-	50	-	M48×1.5	φ56	3	34	φ55	45.5	38	-
φ125	95	140	-	65	-	M64×2	φ71	5	39	φ70	61	51	5
φ140	110	160	-	75	-	M72×2	φ80	5	40	φ79	69	58	5
φ160	120	175	φ162	85	-	M80×2	φ90	5	30	φ89	77	64	5
φ180	140	210	φ172	-	φ12	M95×2	φ100	5	35	φ99	92	76	5
φ200	150	220	φ191	-	φ15	M100×2	φ112	5	33	φ111	97	80	5
φ224	180	265	φ208	-	φ15	M120×2	φ125	5	35	φ124	117	96	5
φ250	195	285	φ229	-	φ15	M130×2	φ140	5	35	φ139	127	104	5

Symbol	Bore	BB	EE	EF	FB	LL	P	R	TF	UF	VF	W	WF	Y	YP
φ50	13	SSA15	95	φ16	178	122	60±0.3	140±0.5	175	-	27	47	20	29	
φ63	14	SSA15	110	φ18	209	141	75±0.5	155±0.5	190	-	35	60	25	41	
φ80	16	SSA20	130	φ20	228	155	90±0.5	180±0.5	220	-	34	59	25	44	
φ100	19	SSA20	160	φ24	239	154	115±0.5	220±0.5	265	-	40	70	30	56	
φ125	22	SSA25	200	φ30	277	174	145±0.5	275±0.8	330	-	45	80	35	69	
φ140	26	SSA25	220	φ33	287	184	160±0.5	305±0.8	365	-	45	85	40	69	
φ160	28	SSA25	330	φ36	278	204	185±0.5	340±0.8	405	92	35	127	45	38	
φ180	30	SSA32	340	φ39	308	224	210±0.5	375±0.8	445	92	40	132	50	43	
φ200	33	SSA40	380	φ42	356	254	230±0.5	410±0.8	485	102	38	140	55	51	
φ224	35	SSA40	430	φ48	366	264	255±0.8	460±0.8	545	112	42	154	60	51	
φ250	38	SSA50	465	φ52	385	274	285±0.8	500±0.8	590	127	48	175	65	60	

FB

70/140M-3 2 FB Bore B B Stroke - A B X

φ40 to φ140

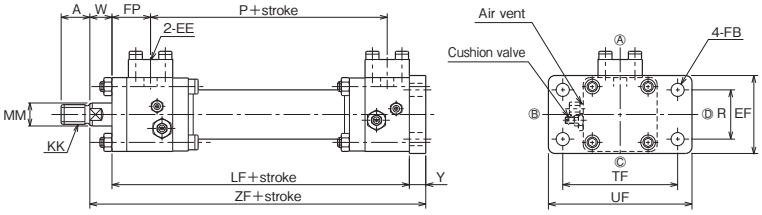

φ160 to φ250

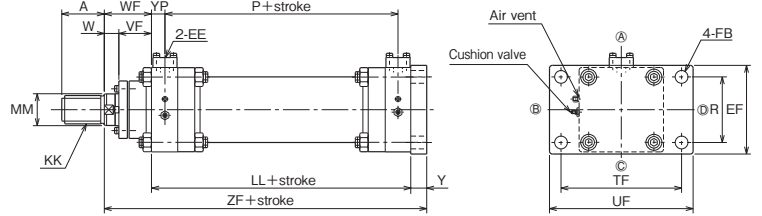

- The following cylinders do not have cushions.
 - For the dimensions of the port flange, refer to "Accessories".
- Rod diameter type A: Rod side of cylinders with bores of 40, 50 and 63 mm
 - The air vent and cushion valve positions vary depending on the cylinder bore.
- Rod diameter type B: Rod side of cylinders with a bore of 40 mm
 - In the case of mounting style FB (φ40 to φ80), the port cannot be positioned on (B) or (D).

Shape of rod end thread

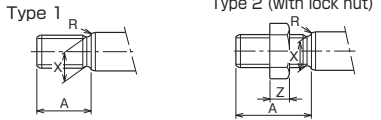

For the dimensions of the lock nut, refer to "Accessories".

Shape of rod end

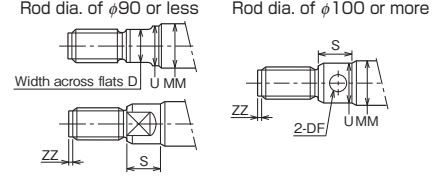

φ40 to φ140

- φ40 · φ50 1/3.5 (1/2.5) stroke+X
- φ63 to φ100 1/4 (1/3) stroke+X
- φ125 · φ140 1/5 (1/3.5) stroke+X

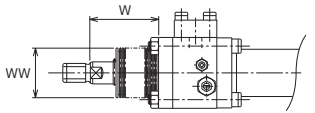

φ160 to φ250

- φ160 to φ200 1/5 (1/3.5) stroke+X
- φ224 · φ250 1/6 (1/4.5) stroke+X

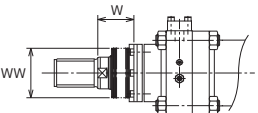

	Standard		Semi-standard	
	Material	Nylon tarpaulin	Chloroprene	Conex
Heat proof	80°C	130°C	200°C	

- Note that the parenthesized values apply in the case of Conex.
- The boots have been mounted at our factory prior to delivery.
- Conex is the registered trademark of Teijin Limited.

Symbol	WW		X
	Rod A	Rod B	
φ40	φ63	φ50	39
φ50	φ71	φ63	55
φ63	φ80	φ71	65
φ80	φ100	φ80	55
φ100	φ125	φ100	64
φ125	φ140	φ125	64
φ140	φ160	φ125	69
φ160	φ180	φ140	66
φ180	φ180	φ160	86
φ200	φ200	φ180	82
φ224	φ220	φ180	86
φ250	φ240	φ200	91

If the calculated value has a fractional part, round it up.

Dimensional Table

Symbol	Rod A											
	A		D	DF	KK	MM	R	S	U	X	Z	ZZ
	Type 1	Type 2										
φ40	35	55	24	—	M24×1.5	φ28	3	—	—	21.5	19	—
φ50	45	65	30	—	M30×1.5	φ35.5	3	—	—	27.5	24	—
φ63	60	85	41	—	M39×1.5	φ45	3	25	φ44	36.5	31	—
φ80	75	105	50	—	M48×1.5	φ56	3	28	φ55	45.5	38	—
φ100	95	140	65	—	M64×2	φ71	5	34	φ70	61	51	5
φ125	120	175	85	—	M80×2	φ90	5	39	φ89	77	64	5
φ140	140	210	—	φ12	M95×2	φ100	5	35	φ99	92	76	5
φ160	150	220	—	φ15	M100×2	φ112	5	30	φ111	97	80	5
φ180	180	265	—	φ15	M120×2	φ125	5	35	φ124	117	96	5
φ200	195	285	—	φ15	M130×2	φ140	5	35	φ139	127	104	5
φ224	225	330	—	φ15	M150×2	φ160	5	35	φ159	147	120	5
φ250	255	375	—	φ15	M170×3	φ180	5	35	φ179	165.5	136	8

Symbol	Rod B											
	A		D	DF	KK	MM	R	S	U	X	Z	ZZ
	Type 1	Type 2										
φ40	30	45	19	—	M20×1.5	φ22.4	3	—	—	17.5	16	—
φ50	35	55	24	—	M24×1.5	φ28	3	—	—	21.5	19	—
φ63	45	65	30	—	M30×1.5	φ35.5	3	25	φ34.5	27.5	24	—
φ80	60	85	41	—	M39×1.5	φ45	3	28	φ44	36.5	31	—
φ100	75	105	50	—	M48×1.5	φ56	3	34	φ55	45.5	38	—
φ125	95	140	65	—	M64×2	φ71	5	39	φ70	61	51	5
φ140	110	160	75	—	M72×2	φ80	5	40	φ79	69	58	5
φ160	120	175	85	—	M80×2	φ90	5	30	φ89	77	64	5
φ180	140	210	—	φ12	M95×2	φ100	5	35	φ99	92	76	5
φ200	150	220	—	φ15	M100×2	φ112	5	33	φ111	97	80	5
φ224	180	265	—	φ15	M120×2	φ125	5	35	φ124	117	96	5
φ250	195	285	—	φ15	M130×2	φ140	5	35	φ139	127	104	5

Symbol	EE	EF	FB	FP	LF	LL	P	R	TF	UF	VF	W	WF	Y	YP	ZF
φ40	SSA15	85	φ14	47	192	—	118	55±0.3	125±0.5	155	—	26	—	15	—	233
φ50	SSA15	95	φ16	47	196	—	122	60±0.3	140±0.5	175	—	27	—	20	—	243
φ63	SSA15	110	φ18	61	229	—	141	75±0.5	155±0.5	190	—	45	—	25	—	299
φ80	SSA20	130	φ20	70	254	—	155	90±0.5	180±0.5	220	—	34	—	25	—	313
φ100	SSA20	160	φ24	87	270	—	154	115±0.5	220±0.5	265	—	39	—	30	—	339
φ125	SSA25	200	φ30	105	313	—	174	145±0.5	275±0.8	330	—	44	—	35	—	392
φ140	SSA25	220	φ33	105	323	—	184	160±0.5	305±0.8	365	—	49	—	40	—	412
φ160	SSA25	250	φ36	—	278	204	185±0.5	340±0.8	405	92	41	133	45	38	456	
φ180	SSA32	280	φ39	—	308	224	210±0.5	375±0.8	445	92	46	138	50	43	496	
φ200	SSA40	305	φ42	—	356	254	230±0.5	410±0.8	485	102	42	144	55	51	555	
φ224	SSA40	345	φ48	—	366	264	255±0.8	460±0.8	545	112	46	158	60	51	584	
φ250	SSA50	380	φ52	—	385	274	285±0.8	500±0.8	590	127	61	188	65	60	638	

CA

70/140M-3 **2** CA Bore **B B** Stroke - **A B 1 X**

φ40 to φ140

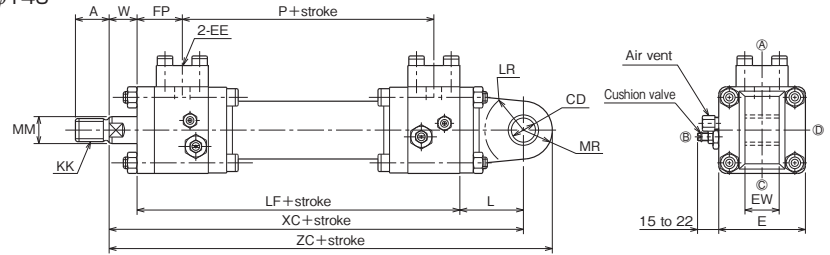

φ160 to φ250

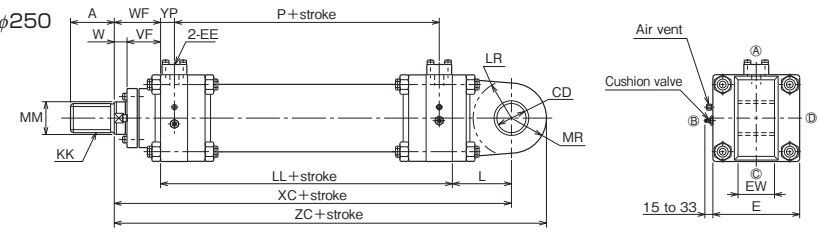

- The following cylinders do not have cushions.
Rod diameter type A : Rod side of cylinders with bores of 40, 50 and 63 mm
Rod diameter type B : Rod side of cylinders with a bore of 40 mm
- For the dimensions of the port flange, refer to "Accessories".
- The air vent and cushion valve positions vary depending on the cylinder bore.

Shape of rod end thread

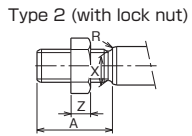
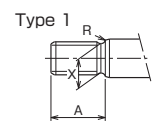

Shape of rod end

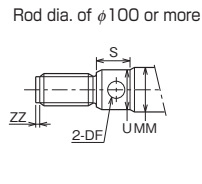
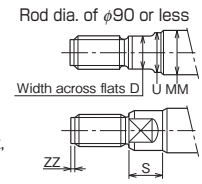

For the dimensions of the lock nut, refer to "Accessories".

φ40 to φ140

- φ40 · φ50 1/3.5 (1/2.5) stroke+X
- φ63 to φ100 1/4 (1/3) stroke+X
- φ125 · φ140 1/5 (1/3.5) stroke+X

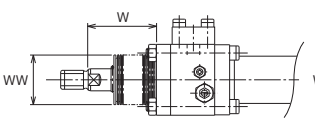

φ160 to φ250

- φ160 to φ200 1/5 (1/3.5) stroke+X
- φ224 · φ250 1/6 (1/4.5) stroke+X

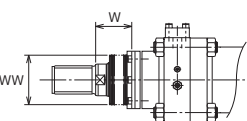

	Standard		Semi-standard	
	Material	Nylon tarpaulin	Chloroprene	Conex
Heat proof	80°C	130°C	200°C	

- Note that the parenthesized values apply in the case of Conex.
- The boots have been mounted at our factory prior to delivery.
- Conex is the registered trademark of Teijin Limited.

Symbol	WW		X
	Rod A	Rod B	
φ40	φ63	φ50	42
φ50	φ71	φ63	57
φ63	φ80	φ71	60
φ80	φ100	φ80	53
φ100	φ125	φ100	64
φ125	φ140	φ125	64
φ140	φ160	φ125	69
φ160	φ180	φ140	60
φ180	φ180	φ160	80
φ200	φ200	φ180	78
φ224	φ220	φ180	82
φ250	φ240	φ200	78

If the calculated value has a fractional part, round it up.

Dimensional Table

Symbol	Rod A											
	A		D	DF	KK	MM	R	S	U	X	Z	ZZ
	Type 1	Type 2										
φ40	35	55	24	—	M24×1.5	φ28	3	—	—	21.5	19	—
φ50	45	65	30	—	M30×1.5	φ35.5	3	—	—	27.5	24	—
φ63	60	85	41	—	M39×1.5	φ45	3	25	φ44	36.5	31	—
φ80	75	105	50	—	M48×1.5	φ56	3	28	φ55	45.5	38	—
φ100	95	140	65	—	M64×2	φ71	5	34	φ70	61	51	5
φ125	120	175	85	—	M80×2	φ90	5	39	φ89	77	64	5
φ140	140	210	—	φ12	M95×2	φ100	5	35	φ99	92	76	5
φ160	150	220	—	φ15	M100×2	φ112	5	30	φ111	97	80	5
φ180	180	265	—	φ15	M120×2	φ125	5	35	φ124	117	96	5
φ200	195	285	—	φ15	M130×2	φ140	5	35	φ139	127	104	5
φ224	225	330	—	φ15	M150×2	φ160	5	35	φ159	147	120	5
φ250	255	375	—	φ15	M170×3	φ180	5	35	φ179	165.5	136	8

Symbol	Rod B											
	A		D	DF	KK	MM	R	S	U	X	Z	ZZ
	Type 1	Type 2										
φ40	30	45	19	—	M20×1.5	φ22.4	3	—	—	17.5	16	—
φ50	35	55	24	—	M24×1.5	φ28	3	—	—	21.5	19	—
φ63	45	65	30	—	M30×1.5	φ35.5	3	25	φ34.5	27.5	24	—
φ80	60	85	41	—	M39×1.5	φ45	3	28	φ44	36.5	31	—
φ100	75	105	50	—	M48×1.5	φ56	3	34	φ55	45.5	38	—
φ125	95	140	65	—	M64×2	φ71	5	39	φ70	61	51	5
φ140	110	160	75	—	M72×2	φ80	5	40	φ79	69	58	5
φ160	120	175	85	—	M80×2	φ90	5	30	φ89	77	64	5
φ180	140	210	—	φ12	M95×2	φ100	5	35	φ99	92	76	5
φ200	150	220	—	φ15	M100×2	φ112	5	33	φ111	97	80	5
φ224	180	265	—	φ15	M120×2	φ125	5	35	φ124	117	96	5
φ250	195	285	—	φ15	M130×2	φ140	5	35	φ139	127	104	5

Symbol	CD	E	EE	EW	FP	L	LF	LL	LR	MR	P	VF	W	WF	XC	YP	ZC
φ40	φ20H10	□80	SSA15	31.5 ^{-0.1} _{-0.4}	47	56	192	—	R30	R24	118	—	29	—	277	—	301
φ50	φ25H10	□90	SSA15	35.5 ^{-0.1} _{-0.4}	47	66	196	—	R40	R30	122	—	29	—	291	—	321
φ63	φ31.5H10	□110	SSA15	40 ^{-0.1} _{-0.4}	61	72	229	—	R43	R38	141	—	40	—	341	—	379
φ80	φ40H10	□127	SSA20	50 ^{-0.1} _{-0.4}	70	86	254	—	R50	R48	155	—	33	—	373	—	421
φ100	φ50H10	□154	SSA20	63 ^{-0.1} _{-0.4}	87	105	270	—	R65	R60	154	—	39	—	414	—	474
φ125	φ63H10	□188	SSA25	80 ^{-0.1} _{-0.6}	105	129	313	—	R82	R75	174	—	44	—	486	—	561
φ140	φ71H10	□212	SSA25	80 ^{-0.1} _{-0.6}	105	147	323	—	R93	R85	184	—	49	—	519	—	604
φ160	φ80H10	□238	SSA25	100 ^{-0.1} _{-0.6}	—	162	—	278	R105	R96	204	92	35	127	567	38	663
φ180	φ90H10	□272	SSA32	125 ^{-0.1} _{-0.6}	—	183	—	308	R120	R108	224	92	40	132	623	43	731
φ200	φ100H10	□298	SSA40	125 ^{-0.1} _{-0.6}	—	189	—	356	R125	R120	254	102	38	140	685	51	805
φ224	φ112H10	□328	SSA40	140 ^{-0.1} _{-0.6}	—	214	—	366	R145	R135	264	112	42	154	734	51	869
φ250	φ125H10	□362	SSA50	160 ^{-0.1} _{-0.6}	—	240	—	385	R160	R150	274	127	48	175	800	60	950

TC

70/140M-3 [2] TC [Bore] [B] [B] [Stroke] - [A] [B] [1] [X]

φ40 to φ140

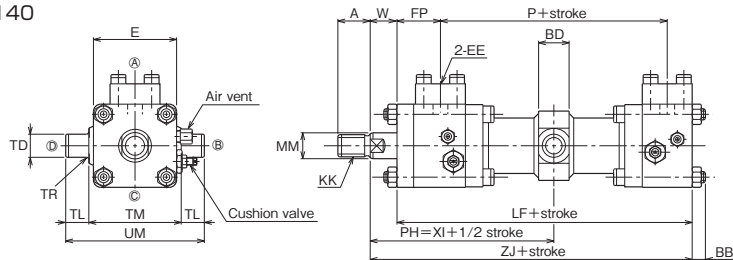

φ160 to φ250

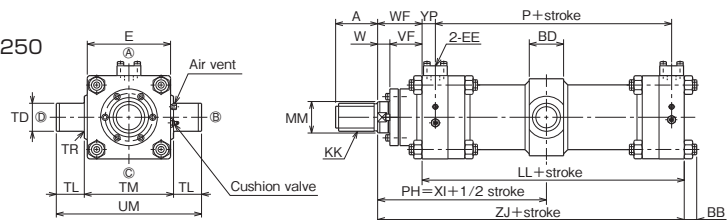

- The following cylinders do not have cushions.
Rod diameter type A : Rod side of cylinders with bores of 40, 50 and 63 mm
Rod diameter type B : Rod side of cylinders with a bore of 40 mm
- For the dimensions of the port flange, refer to "Accessories".
- The air vent and cushion valve positions vary depending on the cylinder bore.

Shape of rod end thread

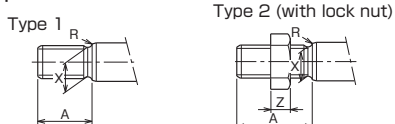

For the dimensions of the lock nut, refer to "Accessories".

Shape of rod end

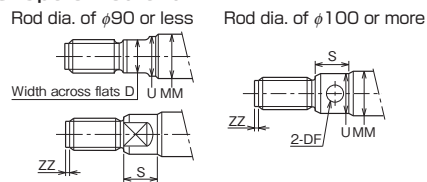

φ40 to φ140

- φ40 · φ50 1/3.5 (1/2.5) stroke+X
- φ63 to φ100 1/4 (1/3) stroke+X
- φ125 · φ140 1/5 (1/3.5) stroke+X

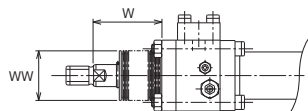

φ160 to φ250

- φ160 to φ200 1/5 (1/3.5) stroke+X
- φ224 · φ250 1/6 (1/4.5) stroke+X

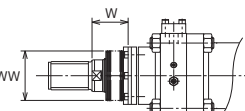

Symbol	WW		X
	Rod A	Rod B	
φ40	φ63	φ50	42
φ50	φ71	φ63	57
φ63	φ80	φ71	60
φ80	φ100	φ80	53
φ100	φ125	φ100	64
φ125	φ140	φ125	64
φ140	φ160	φ125	69
φ160	φ180	φ140	60
φ180	φ180	φ160	80
φ200	φ200	φ180	78
φ224	φ220	φ180	82
φ250	φ240	φ200	78

If the calculated value has a fractional part, round it up.

	Standard		Semi-standard	
	Material	Nylon tarpaulin	Chloroprene	Conex
Heat proof	80°C	130°C	200°C	

- Note that the parenthesized values apply in the case of Conex.
- The boots have been mounted at our factory prior to delivery.
- Conex is the registered trademark of Teijin Limited.

Dimensional Table

Symbol	Rod A											
	A		D	DF	KK	MM	R	S	U	X	Z	ZZ
	Type 1	Type 2										
φ40	35	55	24	—	M24×1.5	φ28	3	—	—	21.5	19	—
φ50	45	65	30	—	M30×1.5	φ35.5	3	—	—	27.5	24	—
φ63	60	85	41	—	M39×1.5	φ45	3	25	φ44	36.5	31	—
φ80	75	105	50	—	M48×1.5	φ56	3	28	φ55	45.5	38	—
φ100	95	140	65	—	M64×2	φ71	5	34	φ70	61	51	5
φ125	120	175	85	—	M80×2	φ90	5	39	φ89	77	64	5
φ140	140	210	—	φ12	M95×2	φ100	5	35	φ99	92	76	5
φ160	150	220	—	φ15	M100×2	φ112	5	30	φ111	97	80	5
φ180	180	265	—	φ15	M120×2	φ125	5	35	φ124	117	96	5
φ200	195	285	—	φ15	M130×2	φ140	5	33	φ139	127	104	5
φ224	225	330	—	φ15	M150×2	φ160	5	35	φ159	147	120	5
φ250	255	375	—	φ15	M170×3	φ180	5	35	φ179	165.5	136	8

Symbol	Rod B											
	A		D	DF	KK	MM	R	S	U	X	Z	ZZ
	Type 1	Type 2										
φ40	30	45	19	—	M20×1.5	φ22.4	3	—	—	17.5	16	—
φ50	35	55	24	—	M24×1.5	φ28	3	—	—	21.5	19	—
φ63	45	65	30	—	M30×1.5	φ35.5	3	25	φ34.5	27.5	24	—
φ80	60	85	41	—	M39×1.5	φ45	3	28	φ44	36.5	31	—
φ100	75	105	50	—	M48×1.5	φ56	3	34	φ55	45.5	38	—
φ125	95	140	65	—	M64×2	φ71	5	39	φ70	61	51	5
φ140	110	160	75	—	M72×2	φ80	5	40	φ79	69	58	5
φ160	120	175	85	—	M80×2	φ90	5	30	φ89	77	64	5
φ180	140	210	—	φ12	M95×2	φ100	5	35	φ99	92	76	5
φ200	150	220	—	φ15	M100×2	φ112	5	33	φ111	97	80	5
φ224	180	265	—	φ15	M120×2	φ125	5	35	φ124	117	96	5
φ250	195	285	—	φ15	M130×2	φ140	5	35	φ139	127	104	5

Symbol	BB	BD	E	EE	FP	LF	LL	P	Min. stroke	Min. PH	TD	TL	TM	TR	UM	VF	W	WF	XI	YP	ZJ
φ40	11	33	□80	SSA15	47	192	—	118	101	166	φ25e8	25	90 ^{+0.1} _{-0.5}	R2.5	140	—	29	—	135	—	221
φ50	13	33	□90	SSA15	47	196	—	122	101	169	φ25e8	25	100 ^{+0.1} _{-0.5}	R2.5	150	—	29	—	137	—	225
φ63	14	43	□110	SSA15	61	229	—	141	101	202	φ31.5e8	31.5	115 ^{+0.1} _{-0.5}	R2.5	178	—	40	—	171.5	—	269
φ80	16	53	□127	SSA20	70	254	—	155	101	227	φ40e8	40	135 ^{+0.1} _{-0.5}	R3	215	—	33	—	180.5	—	287
φ100	19	63	□154	SSA20	87	270	—	154	151	260	φ50e8	50	165 ^{+0.1} _{-0.5}	R3	265	—	39	—	203	—	309
φ125	22	78	□188	SSA25	105	313	—	174	151	300	φ63e8	63	205 ^{+0.1} _{-0.5}	R4	331	—	44	—	236	—	357
φ140	26	88	□212	SSA25	105	323	—	184	201	315	φ71e8	71	225 ^{+0.1} _{-0.5}	R4	367	—	49	—	246	—	372
φ160	28	98	□238	SSA25	—	—	278	204	201	338	φ80e8	80	255 ^{+0.1} _{-0.5}	R4	415	92	35	127	267	38	405
φ180	30	108	□272	SSA32	—	—	308	224	201	363	φ90e8	90	285 ^{+0.1} _{-0.8}	R5	465	92	40	132	287	43	440
φ200	33	118	□298	SSA40	—	—	356	254	201	404	φ100e8	100	310 ^{+0.1} _{-0.8}	R5	510	102	38	140	318	51	496
φ224	35	137	□328	SSA40	—	—	366	264	251	433	φ112e8	112	350 ^{+0.1} _{-0.8}	R5	574	112	42	154	337	51	520
φ250	38	147	□362	SSA50	—	—	385	274	251	478	φ125e8	125	385 ^{+0.1} _{-0.8}	R5	635	127	48	175	372	60	560

Installed absolute position sensor

- The position sensor applying a magnetostriction phenomenon enables high-accuracy absolute position sensing.
- No limit sensor is needed for original position setting, and position correction is not required.
- The sensor has a linearity of $\pm 0.05\%$ FS which cannot be obtained by conventional absolute position sensors. (The linearity indicates the accuracy at the full stroke.)
- The temperature drift of the sensor probe alone is remarkably low, ± 50 ppmFS/C (ppm: 1/1,000,000)
- High-speed sample hold circuit ensures stable output and high response.
- Since the sensor is built in the mill type hydraulic cylinder (70/140M-3 Series), it excels in environmental resistance and durability.
- They are so compact that they are easy to install and space-saving in equipment.

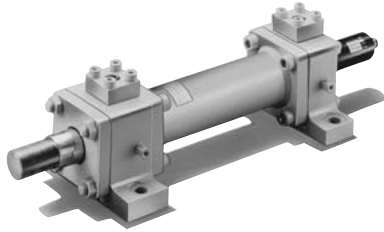

Position Sensor Specifications

Output method		Analog output		Digital output	
Sensor/controller name		GYcRP/GYFC-R9		GYcRP/GYDC-03A	
Accuracy	Linearity	0.05%FS or less			
	Resolution	0.01%FS or less	0.1 or 0.01 mm		
	Repeatability	0.01%FS or less			
	Temperature characteristics	Probe	0.005 mm/°C +10 ppmFS/°C or less		
Controller		± 20 ppm FS/°C			
Output type	Voltage output	0 to +10 V DC	Output level	Open collector output or TTL output	
		Load current : 50 mA max.	Output logic	Positive logic or negative logic	
	Load resistance : 200 Ω min.	Output code		Binary output (19 bits) or BCD output (4-3/4 digits)	
	Current output		4 to 20 mA		
Others	Load resistance : 500 Ω max.	Error output (standard) and speed output (option)			
Scanning frequency		1 KHz (standard)			
Supply voltage		± 15 V DC or +24 V DC		85 to 132 V AC	
Environmental resistance	Working temperature range	Probe	-5°C to +65°C (no freezing)		
		Controller	0°C to +60°C (no freezing)		
	Storage temperature range	-40°C to +80°C (no freezing)			
	Proof pressure	35 MPa, parts in contact with liquid			
	Vibration resistance	58.8 m/s ² (or 40 Hz2mmp)			
	Impact resistance	196 m/s ² 6mS			
Protective structure		IP65 (IEC Standard)			
Cable specifications		Oil-proof cable for composite instrumentation with shield			
Cable length (standard)		With 1.5 m long connector (extendable to up to 200 m)			

• We are ready to produce special models, such as high-temperature (to up to 100°C) models. Please contact us.

Principle of position sensor operation

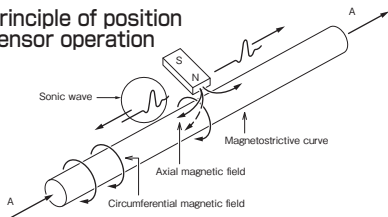

The figure shows the basic principle. When a current pulse shown by arrow A is given to the magnetostrictive curve, a circumferential magnetic field is generated on the magnetostrictive curve. When a magnet is positioned as shown in the figure, an axial magnetic field is given only to the part, and a diagonal magnetic field as shown by the dotted line is generated, thereby causing torsion in this part of the magnetostrictive curve. Since this torsion is a kind of vibration, it propagates at the sonic speed on the magnetostrictive curve which is a metallic tube. 140MT-3 Series uses absolute position sensors which detect the magnet position by measuring the supersonic propagation time.

Cylinder Specifications

Series	140MT-3	
Cylinder bore	$\phi 50 \cdot \phi 63 \cdot \phi 80 \cdot \phi 100 \cdot \phi 125 \cdot \phi 140$	$\phi 160 \cdot \phi 180 \cdot \phi 200 \cdot \phi 224 \cdot \phi 250$
Standard stroke	100 to 1500mm	100 to 2000mm
Nominal pressure	14 MPa	
Maximum allowable pressure	23 MPa	
Proof pressure	28 MPa	
Maximum working speed	500mm/s	
Minimum working speed	10mm/s	20mm/s
Working temperature range	-5°C to +65°C (ambient temp. and oil temp.) (no freezing)	
Structure of cushioning	Metal fitting system	
Applicable fluid	Petroleum-based fluid (When using another fluid, refer to the table of fluid adaptability.)	
Tolerance for thread	JIS 6g	
Mounting style	SD, LA, FA, TC	

Note) The hydraulic pressure generated in a cylinder due to the inertia of load must be lower than the maximum allowable pressure.

The position sensor can be installed in JIS type (70/140H-8) and special cylinders as well as in the mill type hydraulic cylinders. Feel free to contact us.

Sectional Drawing

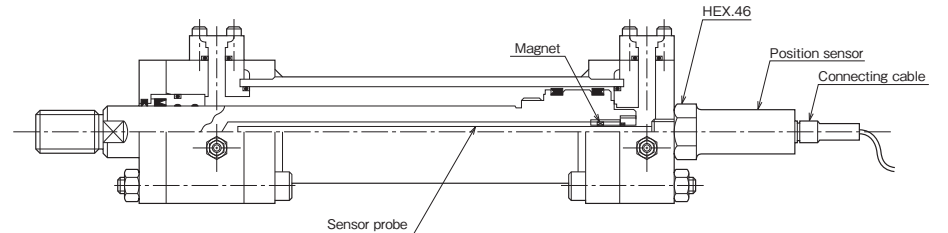

- Notes) 1. For the dimensions of each part of the cylinders, see the catalog of 70/140M-3 Series mill type hydraulic cylinders.
2. Part of the structure may vary depending on the cylinder bore and position sensor type.
3. 140MT-3 Series are provided with a position sensor protecting steel cover.

Application example

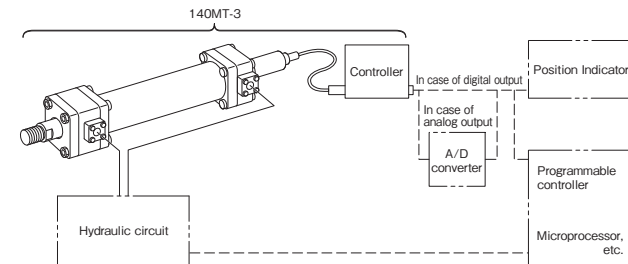

- The cylinder position and operation can be checked on the position indicator, and position adjustment and inching can be easily performed by manual operation.
- When combined with a PC or a microprocessor, the cylinder can be decelerated and stopped at any position.